



Cubicles and sanitary equipment





Where can you find our products ?

Service sector, Well-being areas, Nautical centre, **Campsites**, Fitness centres, Food industries, **Schools**, Service stations, Hospitals, **Swimming pools**, Modular buildings



SUMMARY

Our history - [P. 4](#)

Laminate compact - [P. 5](#)

Technical description - [P. 6](#)

Sanitary cubicles - [P. 7](#)

Cubicles fittings - [P. 14](#)

Vanity units and urinal dividers - [P. 15](#)

Renovated doors and traffic doors - [P. 16](#)

Changing rooms - [P. 17](#)

Range of colours - [P. 19](#)

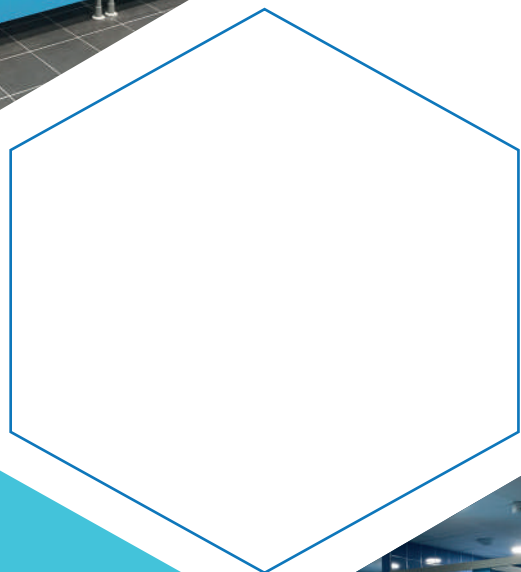
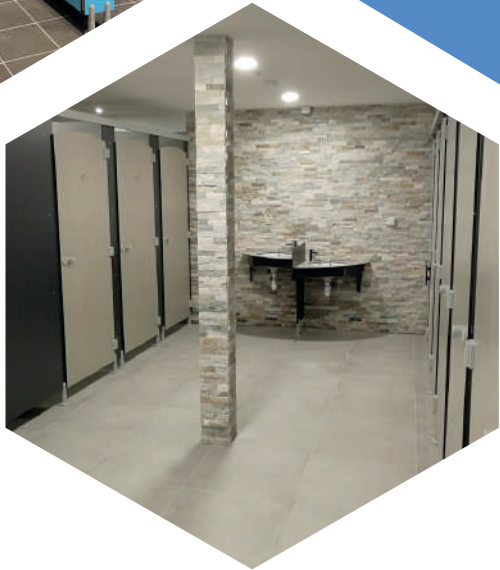

OUR HISTORY

For more than 30 years ...

Since **1989**, QOVANS® company offers through its brand SANICLIPS®, a large range of **cubicles**, of **lockers** and of **sanitary equipment** for the interior fitting of **camping, swimming pools, schools, collectivities, leisure center, hospitals, offices ...**

Made to resist to extreme conditions of use, the SANICLIPS® products answer to **high manufacturing standards** guaranteeing a high quality finish and a perfect aesthetic.

Recognized by architects and persons dedicated to this specific industry, the range SANICLIPS® offers **sustainable** materials that save the maintenance costs and brings together a set of services that give a real **success** to the SANICLIPS® brand today.

Made in France

Located in **Normandy** on an industrial site of **30 000 sq/m**, Qovans® owns an important and performing industrial production tool :



A machining **unit** for laminate panels



A **profile** aluminium **process** unit



A **powder coating** line

Our expertise is recognized thanks to :

- A **performing quality control process**,
- A **logistics department** integrated and dedicated to the delivery of our products,
- A **know how** and a **skilled staff** in this field of activity.

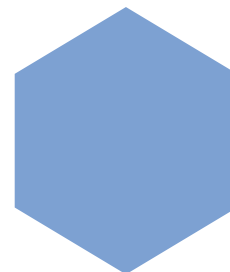
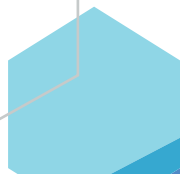

LAMINATE COMPACT

Compact laminate panels are made up of 2 decorative sheets, 70% **kraft paper** and 30% **thermosetting resins**.



The panel is **rot-proof**, **water-repellent** and **extremely resistant to external aggression** (impact, abrasion, chemicals, oxidation, etc.).

The laminate compact panels of the all range Saniclips® benefit of anti bacteria **protection Sanitized®**. Based on antiseptic action of silver ions, the Sanitized protection reduce strongly the proliferation of bacteria throughout the panel use.

The efficiency of Sanitized® anti bacteria treatment, it is **99,9% of annihilated bacteria**.



Resistance to cracking



Shock resistance



Abrasion resistance



Resistance to humidity



Colour fastness to artificial light



Scratch resistance



Easy maintenance



Resistance to chemicals



Norms and rules

Fire Reaction

Sanitary cubicles in laminate compact are considered as large furniture, then a fire regulation of M3 is required. Saniclips® respects and overtakes the norm thanks to the panels used that are classified M2 (C-s1,d0). A version M1 is available on request.

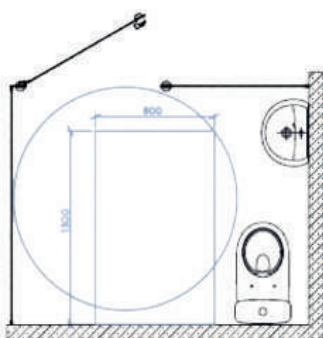

Accessibility and PRM

Following the rules, the minimum allowed passage of a door for a non adapted cubicle is fixed to 800mm and accepted up to 780mm.

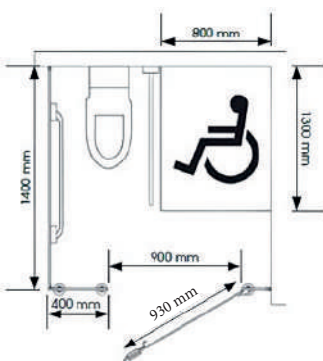

All Saniclips® standard dimensions comply with accessibilities norms to persons with reduced mobility.

(law of 11 February 2005 for equal opportunities law).

TECHNICAL DESCRIPTION

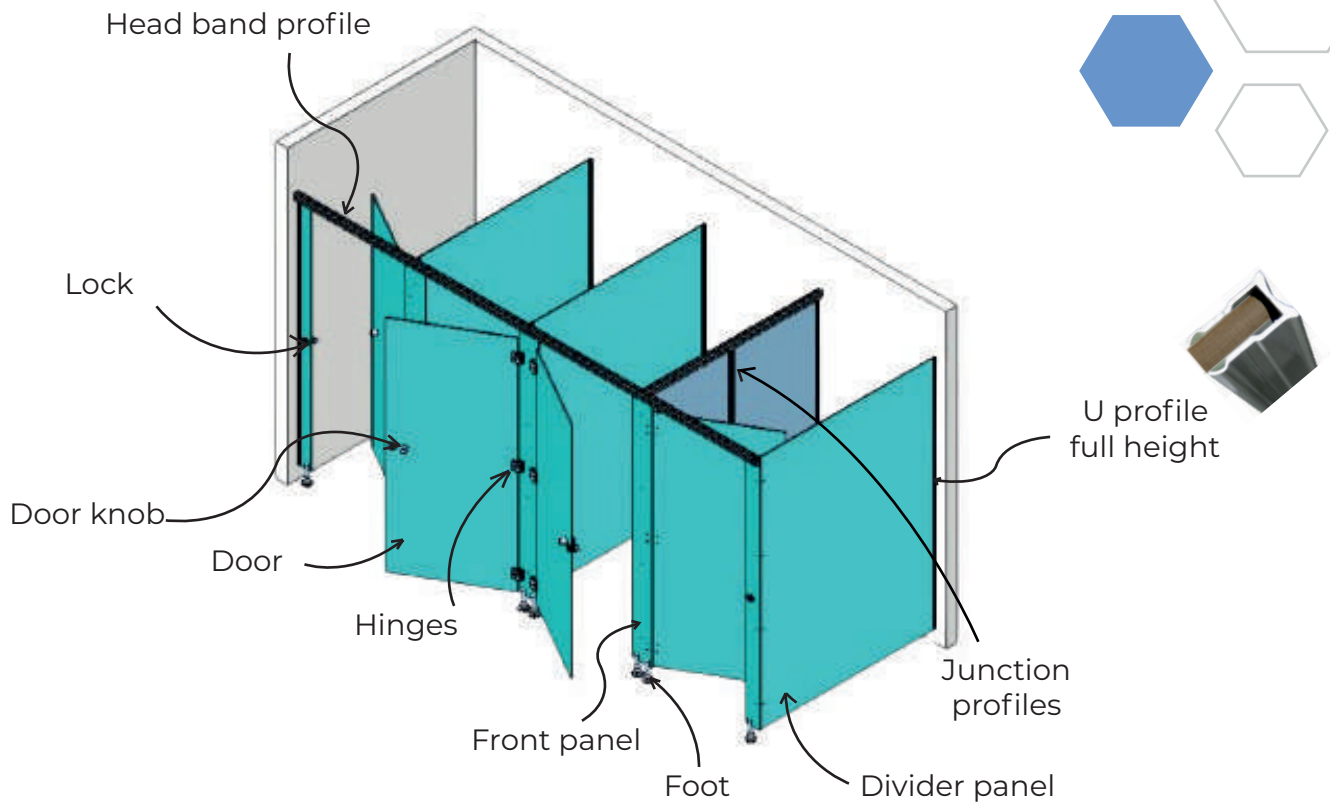

Uses and implantations

WC cubicle, Washbasin, shower or changing room, the uses are versatile.

The equipments diversity gives to cubicles a multiplicity of use.

The implantation varies following the project because of Saniclips® cubicles can be installed between 3 walls, 2 walls or simply fixed against one wall.

The door opening direction fit also, between interior or exterior opening.

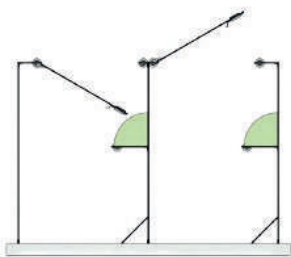

Shower screen and towel holder, 1/4 round bench, shower angle panel



Bench, vanity units, wall panelling support frame

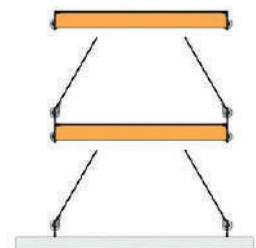

Simultaneous closing of 2 doors

CUBICLES - EPURE 10

The Epure cubicles are specially designed to answer to requests to Establishment Open to the Public.

From laminate compact panel for the **easy maintenance** and **the resistance to impacts**, to **abrasion** and to **scratches**.

From accessories specifically chosen for their durability and the design of the product.

From full height profiles and a system of montage easing a quick and solid installation

Accessories

Grey nylon

Black nylon



Anodised aluminium

Stainless steel



Technical characteristics



Panels

Compact laminate 10 mm



Height

Max 2150 mm - 2020
+ ground clearance 90 to 130 mm



Assembly

Full height with lacquered aluminium profiles



Screws and bolts

A4 stainless steel through



Accessibility

Respecting the accessibility norm EOP



Fire

Fire reaction M2



Pre drilled

Pre drilled elements to ease the installation on site



Door

Height 1885mm rebated with 3 hinges including one with a spring



Accessories

Nylon or anodized aluminium (stainless steel available in option)



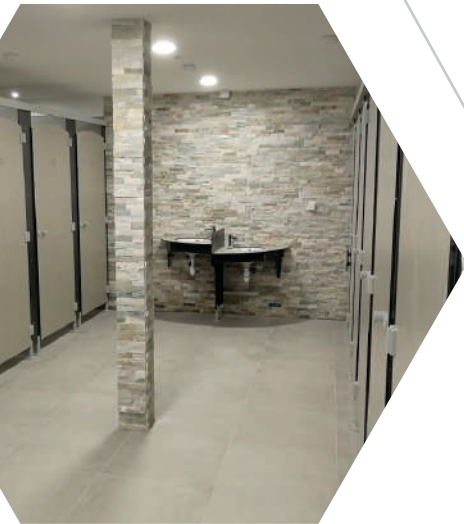



CUBICLES - EPURE 13

The cubicles Epure 13 means more sturdiness and a more aesthetic design with non through screws.

From accessories in nylon or anodized aluminium chosen for their **durability** and the **design** of the product.

From full height profiles and a system of montage well thought for a **quick** and **solid** installation.

Accessories

Grey nylon

Black nylon



Technical characteristics



Panel

Laminate compact 12,5mm



Height

Max 2150mm-2020
+ ground clearance 90 to 130mm



Assembly

Installation on a full height with aluminium lacquered profiles



Screws and bolts

Stainless steel non through screws A4



Accessibility

Respecting the accessibility norm EOP



Fire

Fire reaction M2



Pre drilled

Pre drilled elements to ease the installation on site



Door

Height 1885mm rebated with 3 hinges including one with a spring



Accessories

Nylon or anodized aluminium (stainless steel available in option)



CUBICLES - PRESTIGE

The cubicles Prestige are specifically created to offer a premium product, resistant and refined.

From laminate compact 12,5mm used for the **streight** and the **easy maintenance** of cubicles.

From stainless steel accessories and **non through screws in front panels**.

From flush doors for a **high level finish**.

From brackets and a well thought system of montage for a quick and solid installation.

Accessories

Stainless steel



Technical characteristics



Panel

Laminate compact 12,5mm



Height

Max 2180mm-2020
+ ground clearance 140 to 170mm



Assembly

Installation on a full height with aluminium lacquered profiles



Screws and bolts

Stainless steel nonthrough screws A4, offering a refined design



Accessibility

Respecting the accessibility norm EOP



Fire

Fire reaction M2



Pre drilled

Pre drilled elements to ease the installation on site



Door

Height 2010mm flush with 3 hinges including one with a spring



Accessories

Inox

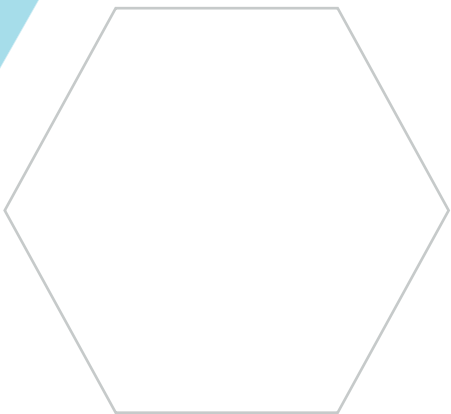
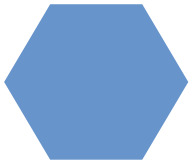

CUBICLES - SANIKIDS

The Sanikids cubicles have been specifically created for the use and the comfort of children in their schools or in any Establishment Open to the Public.

From laminate compact used for **easy maintenance** and the **resistance** to impacts, to abrasion and to scratches.

Child-friendly dimensions.

From fun worlds that provide a friendly **design**.

From full height profiles and a system of montage optimised for a **quick** and **solid installation**.

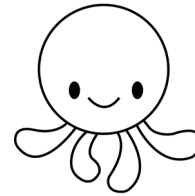
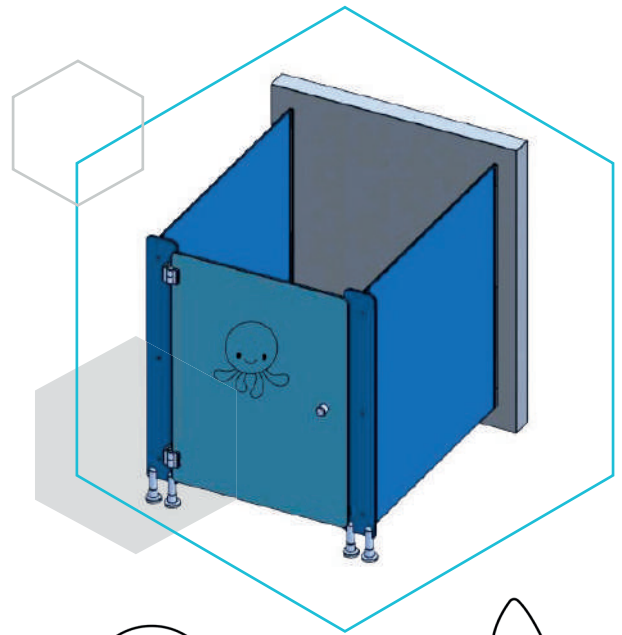

Technical characteristics



Panels

Laminate compact 12,5mm



Height

Maximum 1330mm -1200mm
+ ground clearance 90 to 130mm



Assembly

Installation on a full height with
aluminium lacquered profiles



Fire

Fire reaction M2



Accessibility

Respecting the accessibility norm EOP



Playful engravings



Finger safe system

with wedges and stops



Pre drilled

Pre drilled elements to ease
the installation on site



Door

Height 1250mm flush with 2 hinges
including one with spring



Accessories and screws and bolts

Door feet and hinges :
Nylon RAL 7038
Stainless steel screws A4

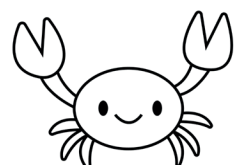

CUBICLES FITTINGS

SHOWER SCREEN, 1/4 ROUND & SHOWER ANGLE PANEL

The shower screen protects from water projection into the cubicle. It comes with a 280mm diameter 1/4 round shelf and a towel rail. The shower angle panel conceals the technical part, and reducing the risk of damage.



Panels

Compact laminate 10 or 12.5 mm
(10 mm shower angle only)
Polished and rounded edges



Assembly profile

Lacquered aluminium



Feet

1 tubular jack foot per shower screen
(nylon / anodised aluminium)



Screws and bolts

Inox A4



Towel rack

In lacquered stainless steel



WALL PANELLING SUPPORT FRAME



Panels

10 mm compact laminate
Polished and rounded edges



Assembly profile

Aluminium



Screws and bolts

A4 stainless
steel through



Installation

Between separation
or with lateral return



VANITY UNITS AND URINAL DIVIDERS

Along the wall or with dividers, inside or outside a cubicle, the vanity unit is declined in a washbasin, dishwasher or linen basin.

VANITY UNITS

Easy to maintain, hygienic and highly resistant



Panels

Compact laminate 10 or 12.5 mm
Polished and rounded edges



Feet

With or without nylon or
anodised aluminium base



Screws and bolts

Not visible from the front



URINAL DIVIDERS

There are two types :

- **adult urinal separators**
- **children's urinal screens**



Panels

Compact laminate 10 or 12.5 mm
Polished and rounded edges



Fixing

With full-height lacquered
aluminium profile



With or without foot

In nylon or anodised aluminium



RENOVATED DOORS AND WESTERN DOORS

Ideal for renovating sanitary blocks with masonry and tiled walls.

RENOVATION DOOR



Panels

Compact laminate 10 or 12.5 mm
Polished and rounded edges



Profiles

Lacquered aluminium



Lock

Nylon, different depending
on opening direction

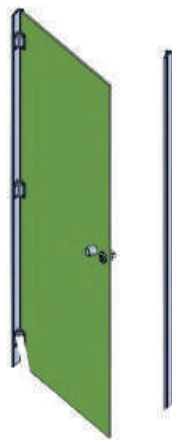

WESTERN DOORS



Panels

Compact laminate 10 or 12.5 mm
Polished and rounded edges



Door leaves

Available in 1 or 2 leaves



Hinges

Stainless steel double-action
spring, adjustable power



CHANGING ROOM - LOCKERS

The products in the cloakroom range have been specially designed for public and private buildings.

Saniclips® wardrobes and lockers can be floor-standing or bench-mounted, with 1 to 7 doors per column. A Z-door model and a clean/dry model for industrial use complete the range.



Technical characteristics



Panel doors and panels

Compact laminate 10 mm
Backs in 6 mm white compact
Polished and rounded edges



Customisable doors

With number engraving



Feet

Lacquered stainless steel,
height 150 mm, adjustable



Fire

Fire reaction M2



Closing

Different systems available, padlock, key or
coin-operated locks with wristband



French-style opening

Stainless steel hinges for French opening



Dimensions of a type 1 to 7 column

W 311 x D 490 x H 1820 mm + foot



Assembly

Pre-assembled riveted aluminium angles
for easy on-site assembly



CHANGING ROOM - BENCHES

The benches of the lockers range are perfectly adapted to busy areas and to wet environments. Resistant to impacts, to scratches and to abrasion, they suit to EOP and collectivities.

Single or double, the benches on feet may be provided with **backs**, **coat hooks** and **packet holder**.

A version on brackets **without floor fixation** is also available.



Technical characteristics



Bench seat

Made of 2 laminate compact panel 2x10 mm fixed together



Back panel

Laminate compact 12,5mm



Screws and bolts

Stainless steel screws A4 non through



Fire

Fire reaction M2



Pre drilled

Pre drilled elements to ease the installation on site



Feet

Grey RAL 7038 polyester powder-coated stainless steel

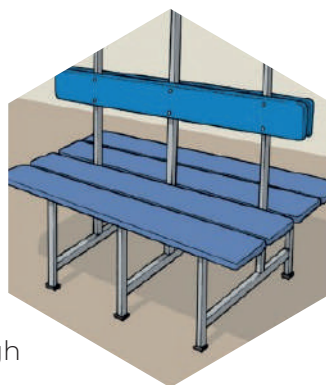

Single bench on legs

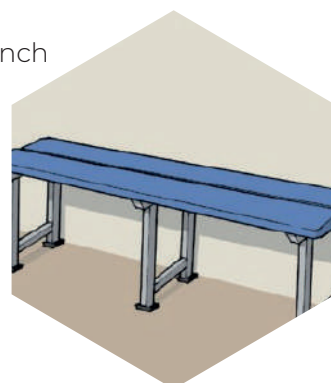

Double bench with backrests

Bench on console + coat hooks + shelf

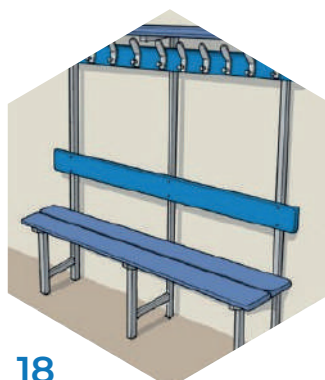
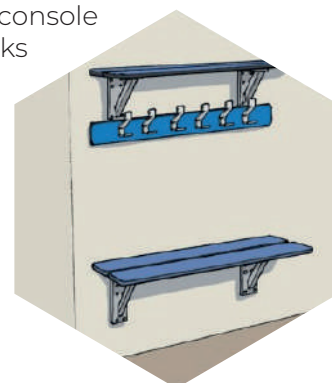

Bench with backrest + coat hooks + shelf

RANGE OF COLOURS



B015
BLANC MÉNUIRES

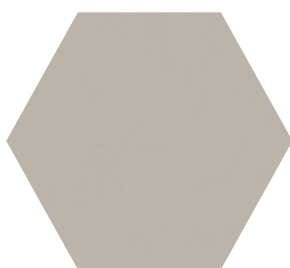

B116
BEIGE NATURE

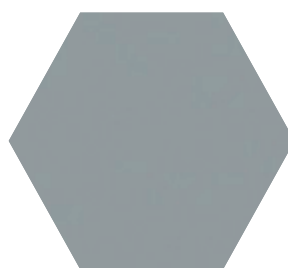

G003
GRIS PERLE

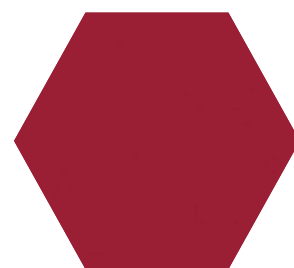

R036
ROUGE CERISE

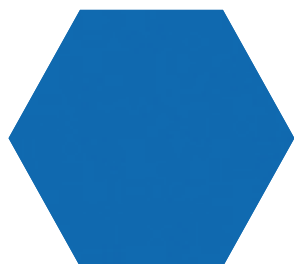

B001
BLEU FLASH

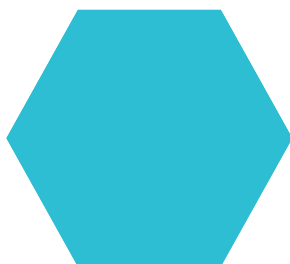

B119
BLEU TURQUOISE



V014
VINYLE

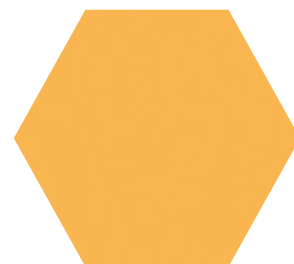

G031
GENET

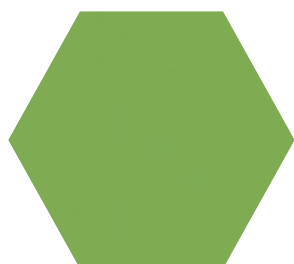

C049
CACTUS

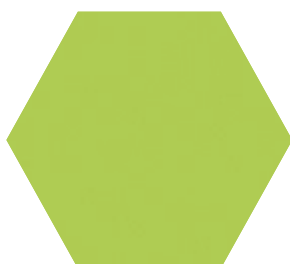

P092
POMME VERTE

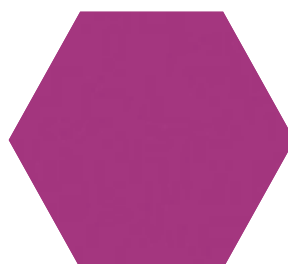

Y022
ROSE BOUGAINVILLÉE

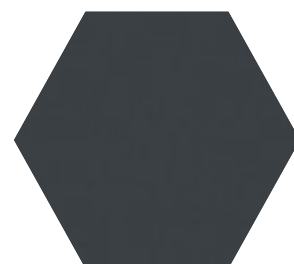

G059
GRIS ORAGE

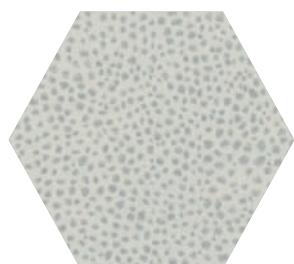

Z022
ZESTE COCO

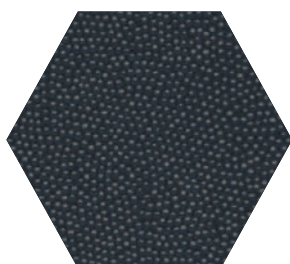

C011
CAVIAR

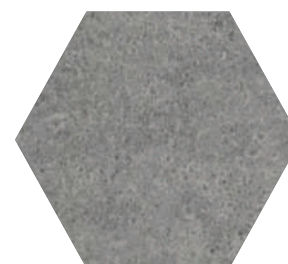

B133
BÉTON BULLE

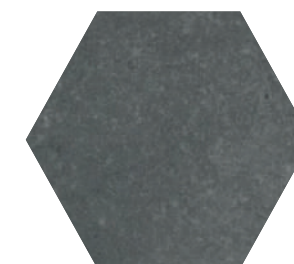

B041
BRASILIA



PICTOGRAMS

Personalise your cabs by adding the engravings of your choice.

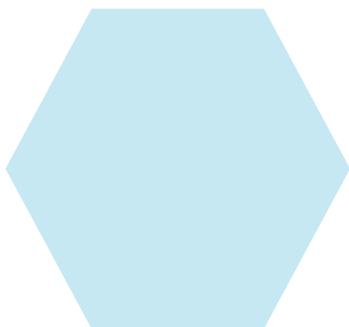
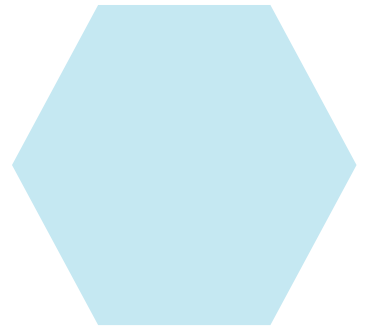

They have put their trust in our partners



Qovans® is also :



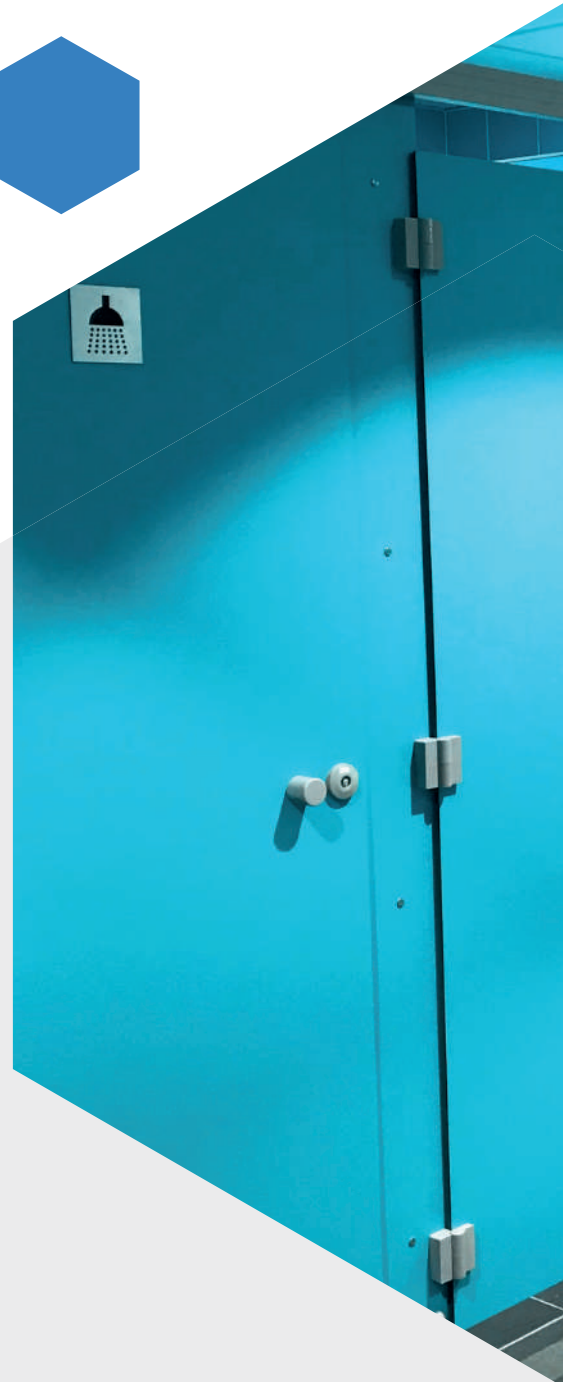
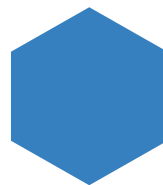

Saniclips

Rue de l'industrie

14700 Falaise France

☎ +33 (0)2 31 40 44 04

✉ saniclips@qovans.com

🌐 www.qovans.com

🌐 Qovans



Qovans®
FAÇONNEZ VOTRE ESPACE